

<b>Line-No.</b>	<b>Date</b>	28.02.2012	<b>Order-No.</b>		<b>Amount</b>		<b>Supplier</b>  <b>Laserpack</b> <b>Fryazino</b>  <b>Die-Side</b>
	<b>Path</b>	aserpack/filesW	<b>Author</b>	Yashin A	<b>Height</b>		
	<b>File</b>	c> ECMA_A2220 .d	<b>Customer</b>		<b>Manufacturer</b>		
	<b>10/15/18</b>		<b>Line type</b>		<b>Material</b>		
	<b>Sonstiges</b>		<b>Pointage</b>		<b>Mat. Table</b>		

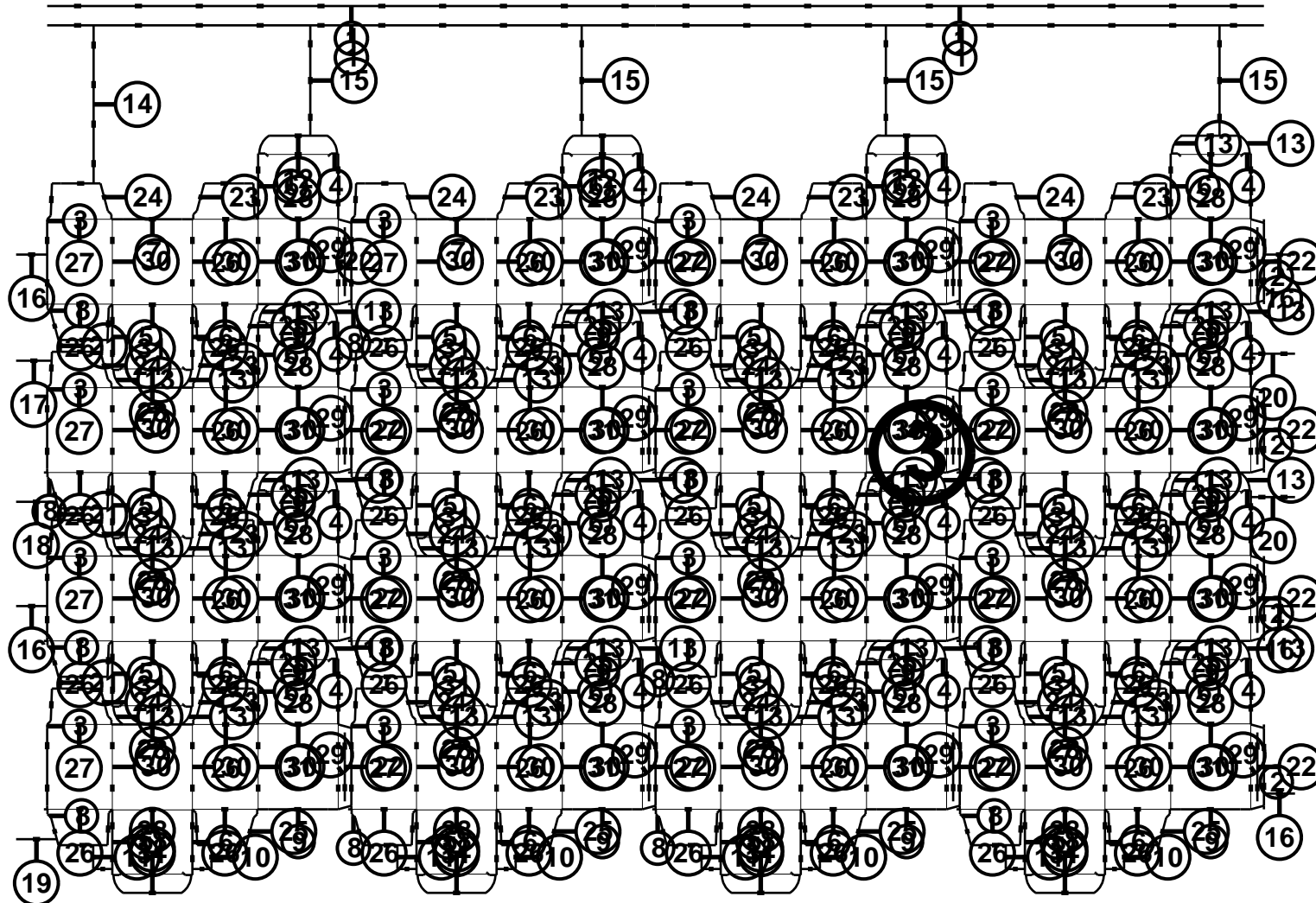



# Rule Processing System ACS 100 for ISO 9000



Line-No.	Date	28.02.2012	Order-No.		Amount		Supplier
	Path	aserpack/filesW	Author	Yashin A	Height		Laserpack Fryazino
	File	c> ECMA_A2220.d	Customer		Manufacturer		
	10/15/18		Line type		Material		Die-Side
	Sonstiges		Pointage		Mat. Table		

Rule Processing System ACS 100 for ISO 9000

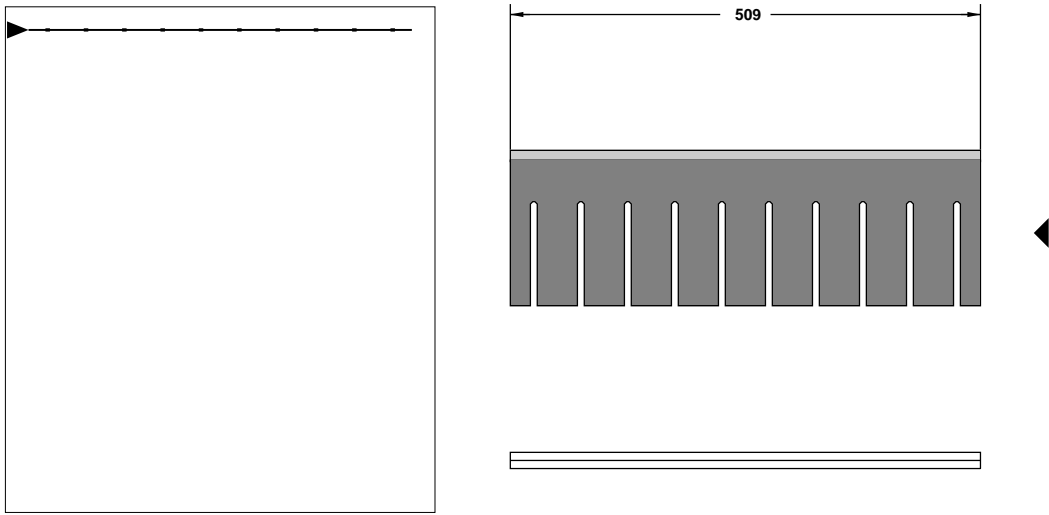

<b>1</b>	Line-No.	Date	28.02.2012	Order-No.		Amount	4	Supplier	
	Path	aserpack/filesW	Author	Yashin A	Height	23.80	<b>Laserpack Fryazino</b>		
	File	c> ECMA_A2220	Customer		Manufacturer	Boehler			
	10/15/18		Line type	Cut	Material	UNIVERSAL-T30			
	Sonstiges		Pointage	2.00	Mat. Table	04	Die-Side		

Rule Processing System ACS 100 for ISO 9000

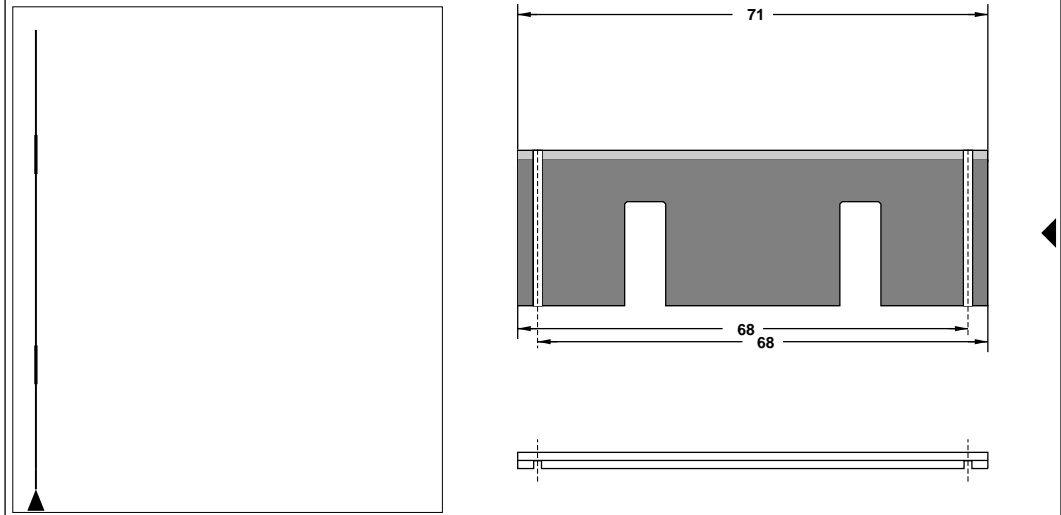

<b>2</b>	Line-No.	Date	28.02.2012	Order-No.		Amount	4	Supplier	
	Path	aserpack/filesW	Author	Yashin A	Height	23.80	<b>Laserpack Fryazino</b>		
	File	c> ECMA_A2220	Customer		Manufacturer	Boehler			
	10/15/18		Line type	Cut	Material	UNIVERSAL-T30			
	Sonstiges		Pointage	2.00	Mat. Table	04	Die-Side		

Rule Processing System ACS 100 for ISO 9000

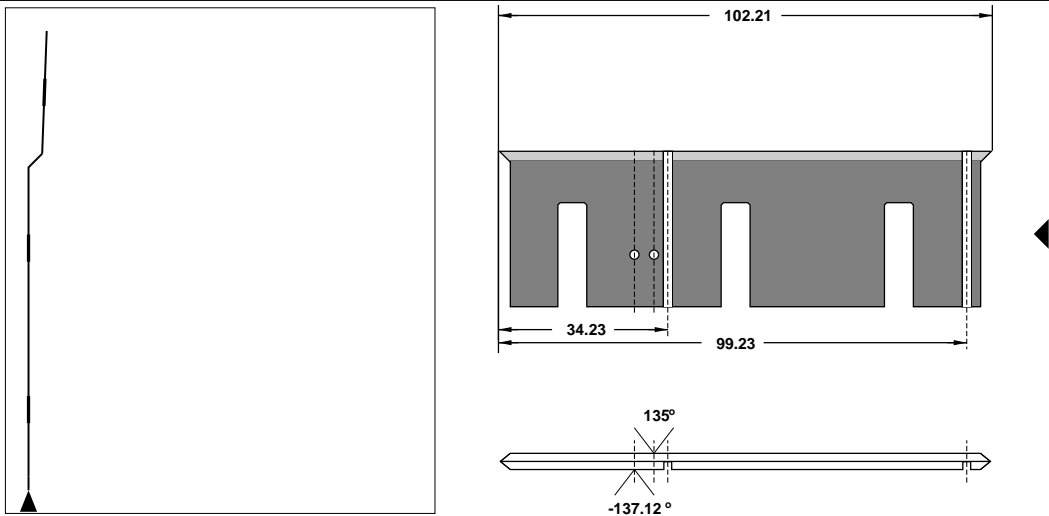

<b>3</b>	Line-No.	Date	28.02.2012	Order-No.		Amount	16	Supplier	
	Path	aserpack/filesW	Author	Yashin A	Height	23.80	<b>Laserpack Fryazino</b>		
	File	c> ECMA_A2220	Customer		Manufacturer	Boehler			
	10/15/18		Line type	Cut	Material	UNIVERSAL-T30			
	Sonstiges		Pointage	2.00	Mat. Table	04	Die-Side		

Rule Processing System ACS 100 for ISO 9000

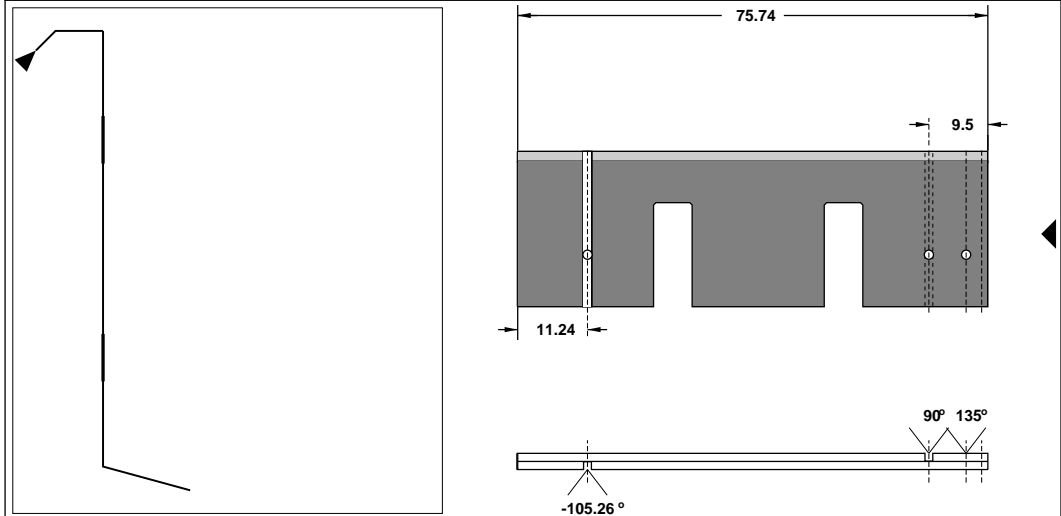

<b>4</b>	Line-No.	Date	28.02.2012	Order-No.		Amount	16	Supplier	
	Path	aserpack/filesW	Author	Yashin A	Height	23.80	<b>Laserpack Fryazino</b>		
	File	c> ECMA_A2220	Customer		Manufacturer	Boehler			
	10/15/18		Line type	PERFO	Material	UNIVERSAL-T30			
	Sonstiges		Pointage	2.00	Mat. Table	04	Die-Side		

Rule Processing System ACS 100 for ISO 9000

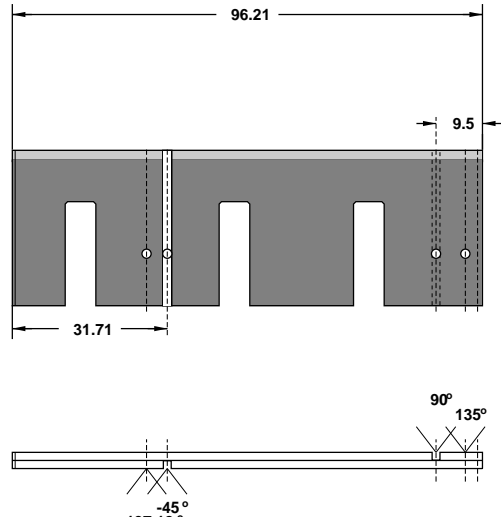
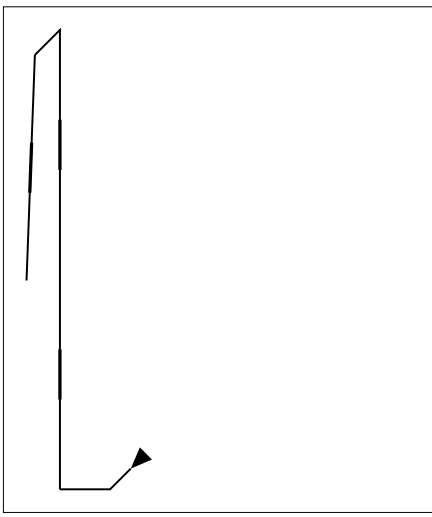

<b>Line-No.</b>	<b>Date</b>	28.02.2012	<b>Order-No.</b>		<b>Amount</b>	16	<b>Supplier</b>
<b>5</b>	<b>Path</b>	aserpack/filesW	<b>Author</b>	Yashin A	<b>Height</b>	23.80	<b>Laserpack Fryazino</b>
	<b>File</b>	c> ECMA_A2220.d	<b>Customer</b>		<b>Manufacturer</b>	Boehler	
	<b>10/15/18</b>		<b>Line type</b>	PERFO	<b>Material</b>	UNIVERSAL-T30	
	<b>Sonstiges</b>		<b>Pointage</b>	2.00	<b>Mat. Table</b>	04	
					<b>Die-Side</b>		

Rule Processing System ACS 100 for ISO 9000

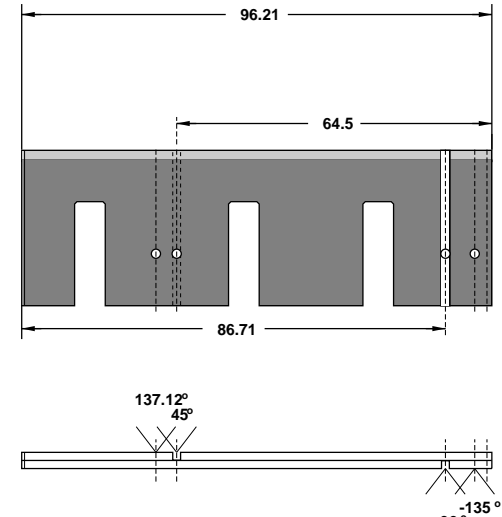
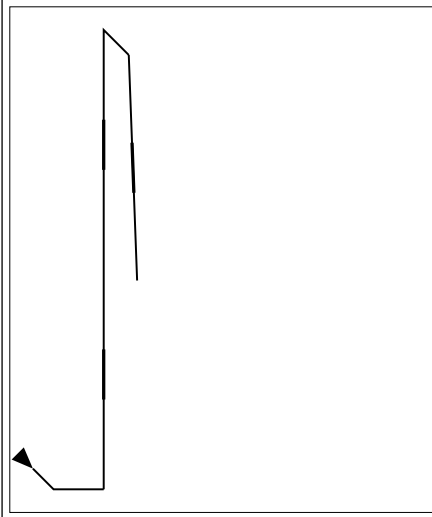

<b>Line-No.</b>	<b>Date</b>	28.02.2012	<b>Order-No.</b>		<b>Amount</b>	32	<b>Supplier</b>
<b>6</b>	<b>Path</b>	aserpack/filesW	<b>Author</b>	Yashin A	<b>Height</b>	23.80	<b>Laserpack Fryazino</b>
	<b>File</b>	c> ECMA_A2220.d	<b>Customer</b>		<b>Manufacturer</b>	Boehler	
	<b>10/15/18</b>		<b>Line type</b>	PERFO	<b>Material</b>	UNIVERSAL-T30	
	<b>Sonstiges</b>		<b>Pointage</b>	2.00	<b>Mat. Table</b>	04	
					<b>Die-Side</b>		

Rule Processing System ACS 100 for ISO 9000

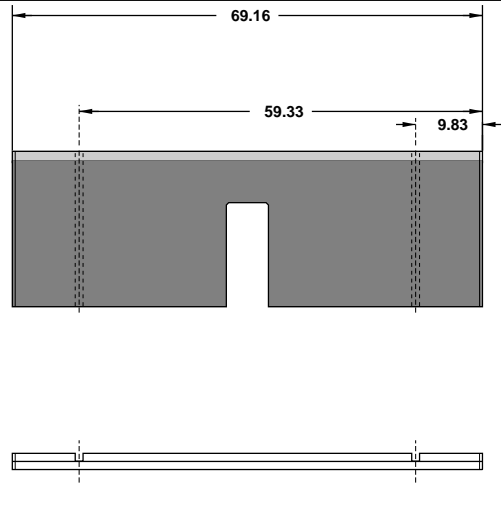
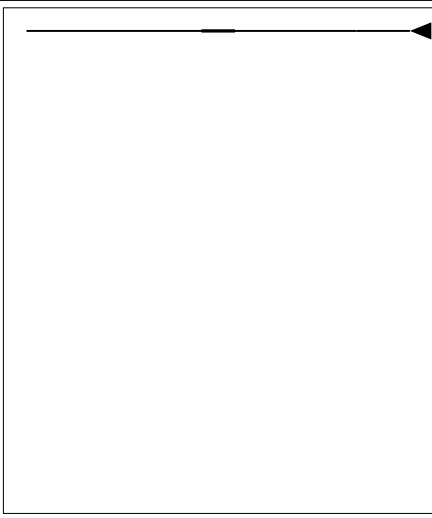

<b>Line-No.</b>	<b>Date</b>	28.02.2012	<b>Order-No.</b>		<b>Amount</b>	16	<b>Supplier</b>
<b>7</b>	<b>Path</b>	aserpack/filesW	<b>Author</b>	Yashin A	<b>Height</b>	23.80	<b>Laserpack Fryazino</b>
	<b>File</b>	c> ECMA_A2220.d	<b>Customer</b>		<b>Manufacturer</b>	Boehler	
	<b>10/15/18</b>		<b>Line type</b>	Cut	<b>Material</b>	UNIVERSAL-T30	
	<b>Sonstiges</b>		<b>Pointage</b>	2.00	<b>Mat. Table</b>	04	
					<b>Die-Side</b>		

Rule Processing System ACS 100 for ISO 9000

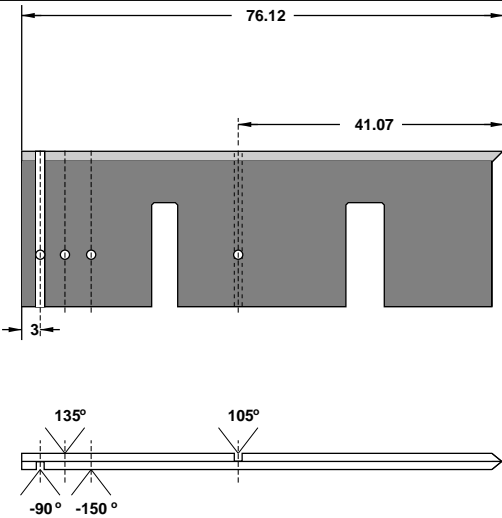
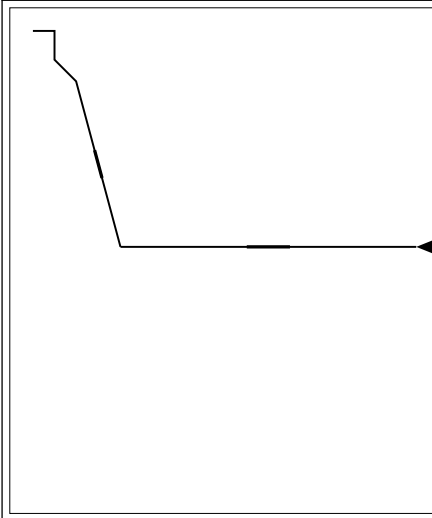

<b>Line-No.</b>	<b>Date</b>	28.02.2012	<b>Order-No.</b>		<b>Amount</b>	16	<b>Supplier</b>
<b>8</b>	<b>Path</b>	aserpack/filesW	<b>Author</b>	Yashin A	<b>Height</b>	23.80	<b>Laserpack Fryazino</b>
	<b>File</b>	c> ECMA_A2220.d	<b>Customer</b>		<b>Manufacturer</b>	Boehler	
	<b>10/15/18</b>		<b>Line type</b>	Cut	<b>Material</b>	UNIVERSAL-T30	
	<b>Sonstiges</b>		<b>Pointage</b>	2.00	<b>Mat. Table</b>	04	
					<b>Die-Side</b>		

Rule Processing System ACS 100 for ISO 9000

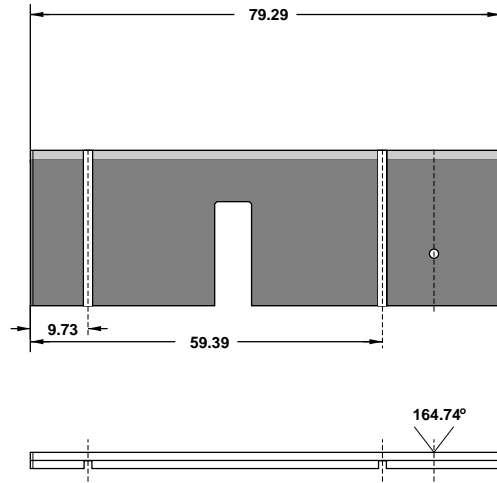
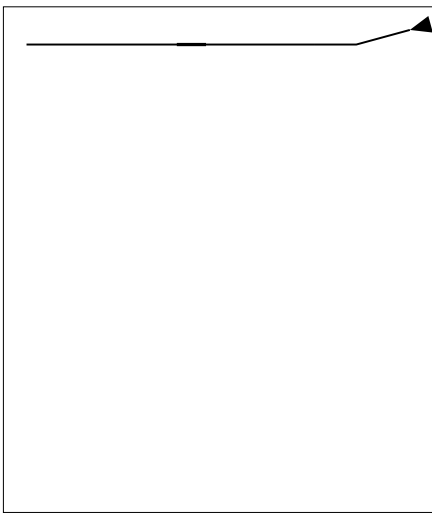

9	Line-No.	Date	28.02.2012	Order-No.		Amount	16	Supplier	
	Path	aserpack/filesW	Author	Yashin A	Height	23.80		<b>Laserpack Fryazino</b>	
	File	c> ECMA_A2220	Customer		Manufacturer	Boehler			
	10/15/18		Line type	Cut	Material	UNIVERSAL-T30			
	Sonstiges		Pointage	2.00	Mat. Table	04	Die-Side		

Rule Processing System ACS 100 for ISO 9000

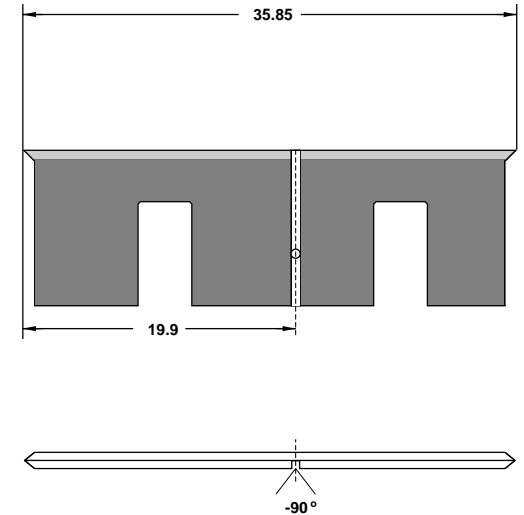
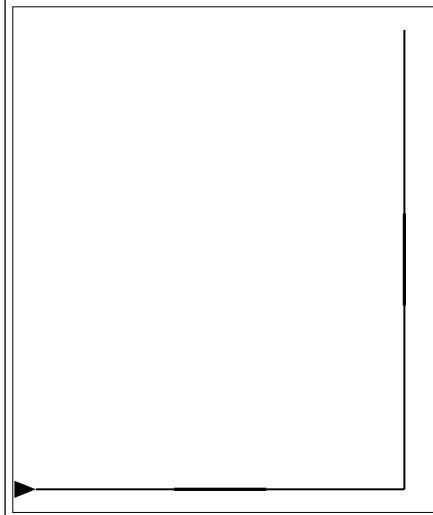

10	Line-No.	Date	28.02.2012	Order-No.		Amount	4	Supplier	
	Path	aserpack/filesW	Author	Yashin A	Height	23.80		<b>Laserpack Fryazino</b>	
	File	c> ECMA_A2220	Customer		Manufacturer	Boehler			
	10/15/18		Line type	Cut	Material	UNIVERSAL-T30			
	Sonstiges		Pointage	2.00	Mat. Table	04	Die-Side		

Rule Processing System ACS 100 for ISO 9000

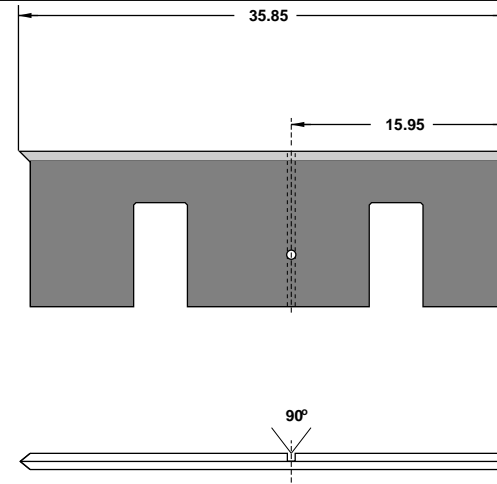
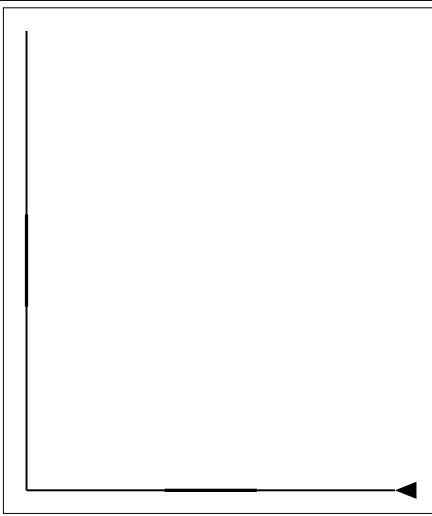

11	Line-No.	Date	28.02.2012	Order-No.		Amount	4	Supplier	
	Path	aserpack/filesW	Author	Yashin A	Height	23.80		<b>Laserpack Fryazino</b>	
	File	c> ECMA_A2220	Customer		Manufacturer	Boehler			
	10/15/18		Line type	Cut	Material	UNIVERSAL-T30			
	Sonstiges		Pointage	2.00	Mat. Table	04	Die-Side		

Rule Processing System ACS 100 for ISO 9000

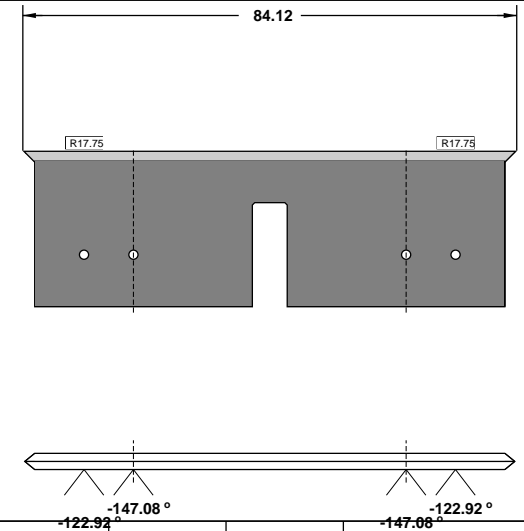
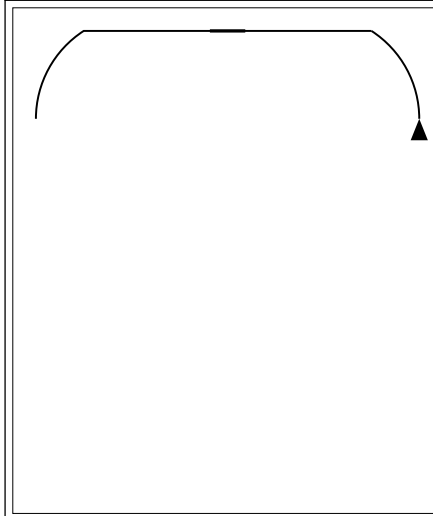

12	Line-No.	Date	28.02.2012	Order-No.		Amount	8	Supplier	
	Path	aserpack/filesW	Author	Yashin A	Height	23.80		<b>Laserpack Fryazino</b>	
	File	c> ECMA_A2220	Customer		Manufacturer	Boehler			
	10/15/18		Line type	Cut	Material	UNIVERSAL-T30			
	Sonstiges		Pointage	2.00	Mat. Table	04	Die-Side		

Rule Processing System ACS 100 for ISO 9000

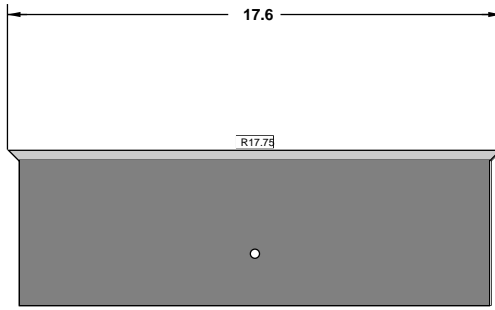
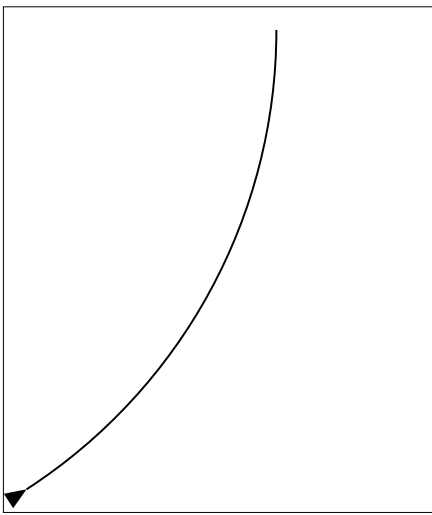

<b>13</b>	Line-No.	Date	28.02.2012	Order-No.		Amount	50	Supplier
	Path	asercpack/filesW	Author	Yashin A	Height	23.80	<b>Laserpack Fryazino</b>	
	File	c> ECMA_A2220	Customer		Manufacturer	Boehler		
	10/15/18		Line type	Cut	Material	UNIVERSAL-T30		
	Sonstiges		Pointage	2.00	Mat. Table	04	<b>Die-Side</b>	

Rule Processing System ACS 100 for ISO 9000

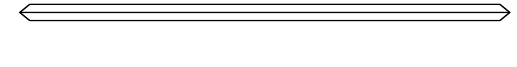
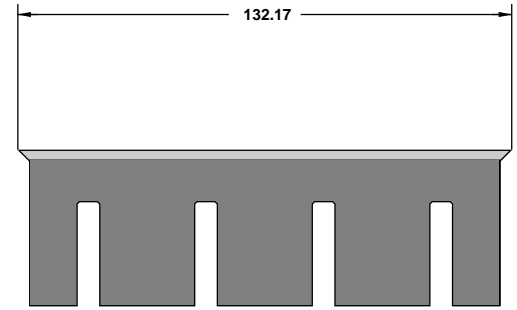
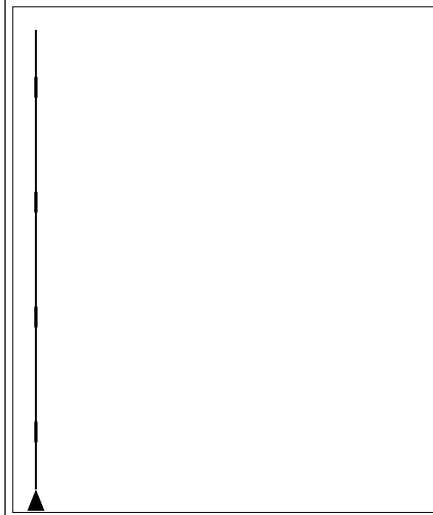

<b>14</b>	Line-No.	Date	28.02.2012	Order-No.		Amount	1	Supplier
	Path	asercpack/filesW	Author	Yashin A	Height	23.80	<b>Laserpack Fryazino</b>	
	File	c> ECMA_A2220	Customer		Manufacturer	Boehler		
	10/15/18		Line type	Cut	Material	UNIVERSAL-T30		
	Sonstiges		Pointage	2.00	Mat. Table	04	<b>Die-Side</b>	

Rule Processing System ACS 100 for ISO 9000

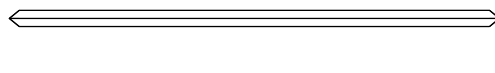
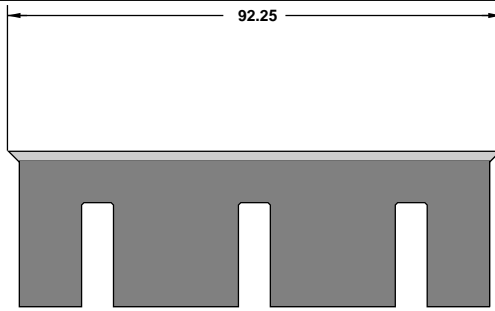
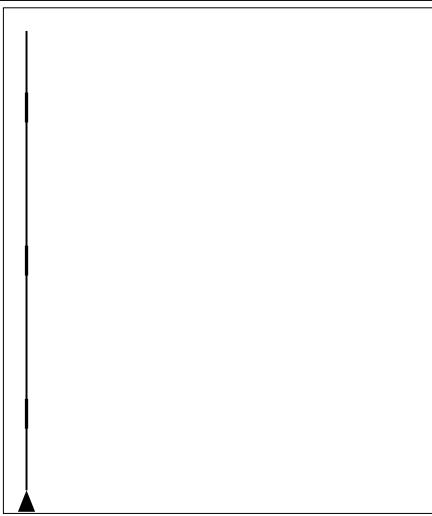

<b>15</b>	Line-No.	Date	28.02.2012	Order-No.		Amount	4	Supplier
	Path	asercpack/filesW	Author	Yashin A	Height	23.80	<b>Laserpack Fryazino</b>	
	File	c> ECMA_A2220	Customer		Manufacturer	Boehler		
	10/15/18		Line type	Cut	Material	UNIVERSAL-T30		
	Sonstiges		Pointage	2.00	Mat. Table	04	<b>Die-Side</b>	

Rule Processing System ACS 100 for ISO 9000

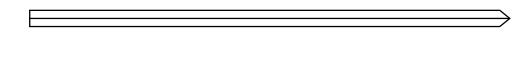
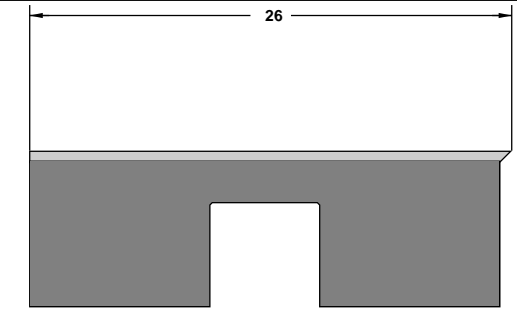

<b>16</b>	Line-No.	Date	28.02.2012	Order-No.		Amount	5	Supplier
	Path	asercpack/filesW	Author	Yashin A	Height	23.80	<b>Laserpack Fryazino</b>	
	File	c> ECMA_A2220	Customer		Manufacturer	Boehler		
	10/15/18		Line type	Cut	Material	UNIVERSAL-T30		
	Sonstiges		Pointage	2.00	Mat. Table	04	<b>Die-Side</b>	



Rule Processing System ACS 100 for ISO 9000

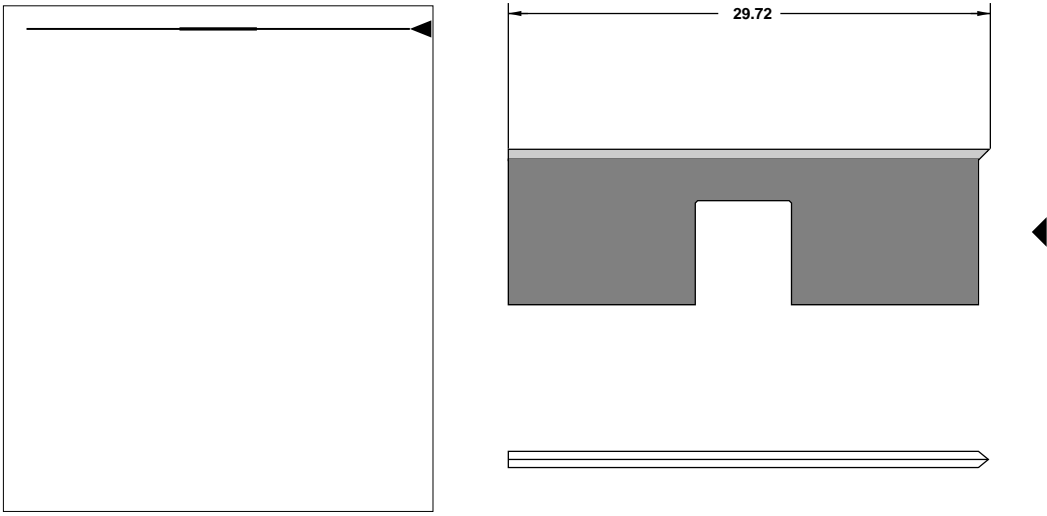

<b>17</b>	<b>Line-No.</b>		<b>Date</b>	28.02.2012	<b>Order-No.</b>		<b>Amount</b>	1	<b>Supplier</b>	
	<b>Path</b>	aserpack/filesW	<b>Author</b>	Yashin A	<b>Height</b>	23.80	<b>Laserpack Fryazino</b>			
	<b>File</b>	c> ECMA_A2220.d	<b>Customer</b>		<b>Manufacturer</b>	Boehler				
	<b>10/15/18</b>		<b>Line type</b>	Cut	<b>Material</b>	UNIVERSAL-T30				
	<b>Sonstiges</b>		<b>Pointage</b>	2.00	<b>Mat. Table</b>	04	<b>Die-Side</b>			

Rule Processing System ACS 100 for ISO 9000

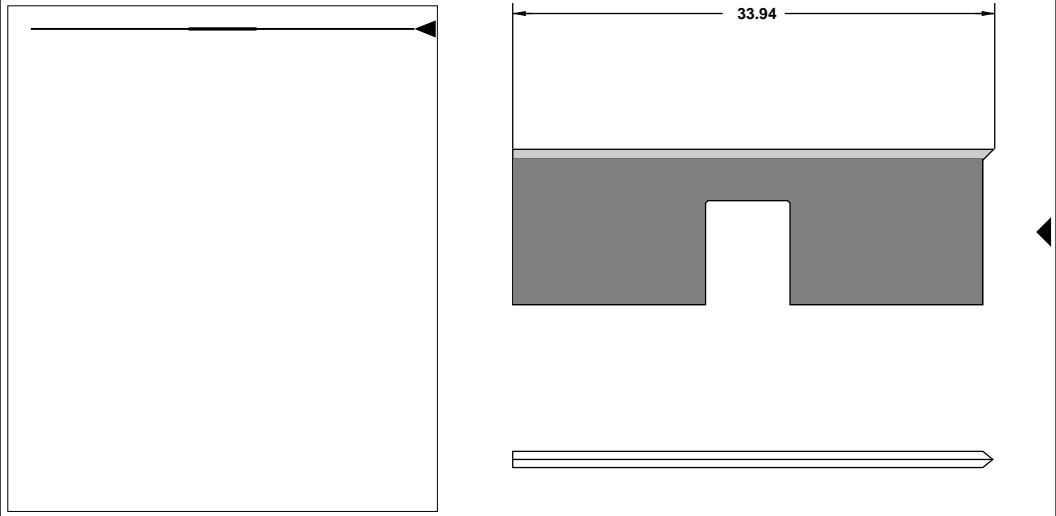

<b>18</b>	<b>Line-No.</b>		<b>Date</b>	28.02.2012	<b>Order-No.</b>		<b>Amount</b>	1	<b>Supplier</b>	
	<b>Path</b>	aserpack/filesW	<b>Author</b>	Yashin A	<b>Height</b>	23.80	<b>Laserpack Fryazino</b>			
	<b>File</b>	c> ECMA_A2220.d	<b>Customer</b>		<b>Manufacturer</b>	Boehler				
	<b>10/15/18</b>		<b>Line type</b>	Cut	<b>Material</b>	UNIVERSAL-T30				
	<b>Sonstiges</b>		<b>Pointage</b>	2.00	<b>Mat. Table</b>	04	<b>Die-Side</b>			

Rule Processing System ACS 100 for ISO 9000

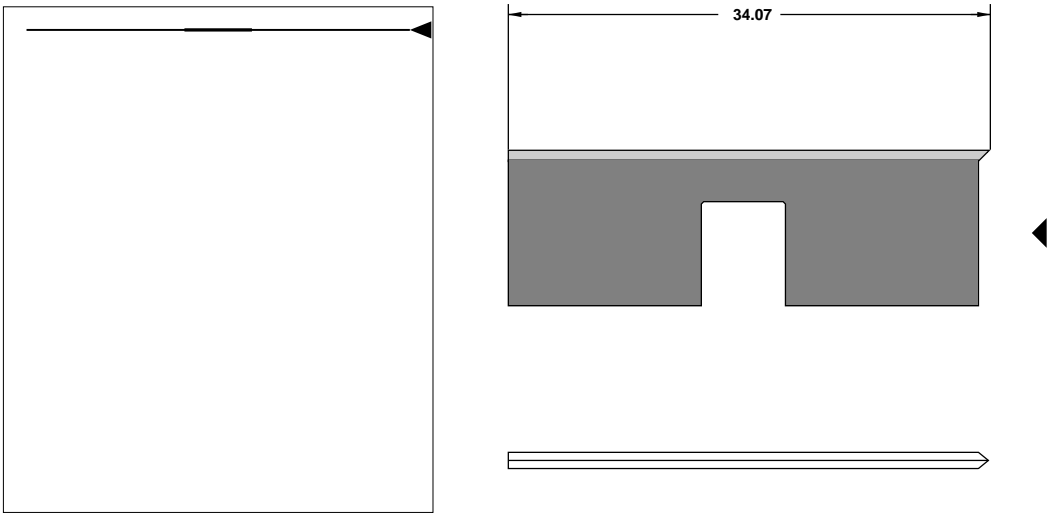

<b>19</b>	<b>Line-No.</b>		<b>Date</b>	28.02.2012	<b>Order-No.</b>		<b>Amount</b>	1	<b>Supplier</b>	
	<b>Path</b>	aserpack/filesW	<b>Author</b>	Yashin A	<b>Height</b>	23.80	<b>Laserpack Fryazino</b>			
	<b>File</b>	c> ECMA_A2220.d	<b>Customer</b>		<b>Manufacturer</b>	Boehler				
	<b>10/15/18</b>		<b>Line type</b>	Cut	<b>Material</b>	UNIVERSAL-T30				
	<b>Sonstiges</b>		<b>Pointage</b>	2.00	<b>Mat. Table</b>	04	<b>Die-Side</b>			

Rule Processing System ACS 100 for ISO 9000

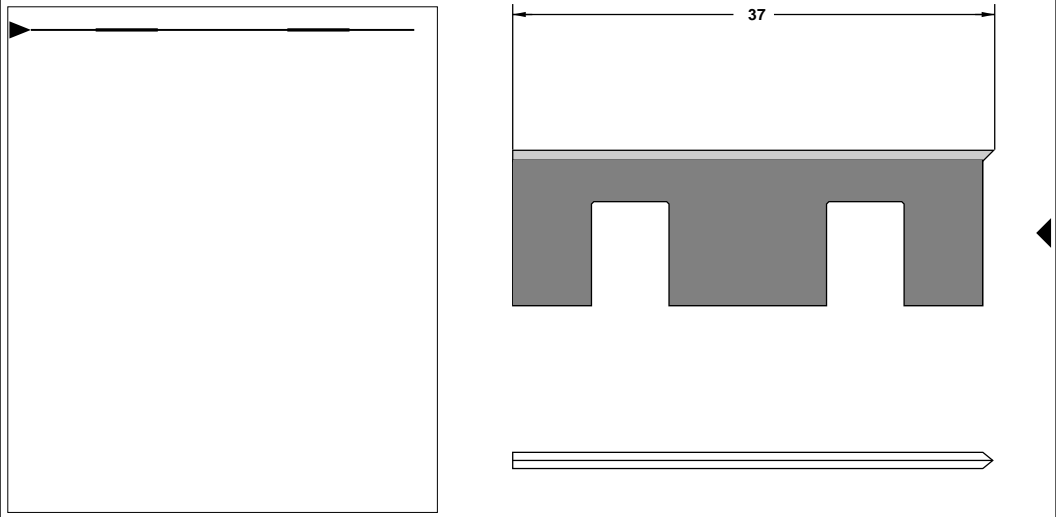

<b>20</b>	<b>Line-No.</b>		<b>Date</b>	28.02.2012	<b>Order-No.</b>		<b>Amount</b>	2	<b>Supplier</b>	
	<b>Path</b>	aserpack/filesW	<b>Author</b>	Yashin A	<b>Height</b>	23.80	<b>Laserpack Fryazino</b>			
	<b>File</b>	c> ECMA_A2220.d	<b>Customer</b>		<b>Manufacturer</b>	Boehler				
	<b>10/15/18</b>		<b>Line type</b>	Cut	<b>Material</b>	UNIVERSAL-T30				
	<b>Sonstiges</b>		<b>Pointage</b>	2.00	<b>Mat. Table</b>	04	<b>Die-Side</b>			

Rule Processing System ACS 100 for ISO 9000

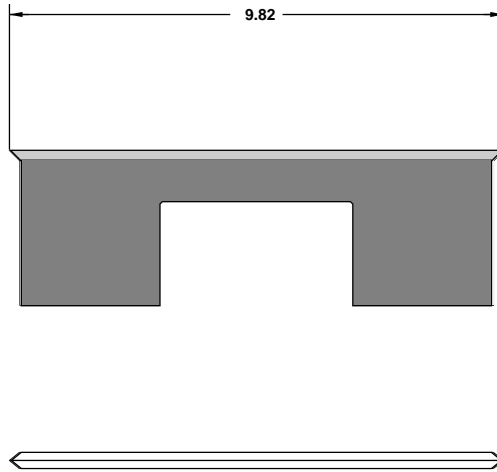
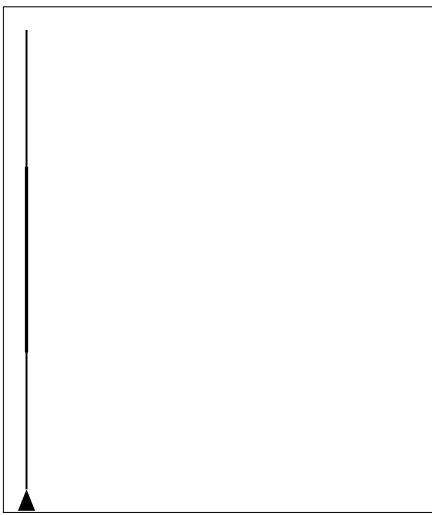

<b>21</b>	Line-No.	Date	28.02.2012	Order-No.		Amount	3	Supplier
	Path	asercpack/filesW	Author	Yashin A	Height	23.80	Laserpack Fryazino	
	File	c> ECMA_A2220	Customer		Manufacturer	Boehler		
	10/15/18		Line type	Cut	Material	UNIVERSAL-T30		
	Sonstiges		Pointage	2.00	Mat. Table	04	Die-Side	

Rule Processing System ACS 100 for ISO 9000

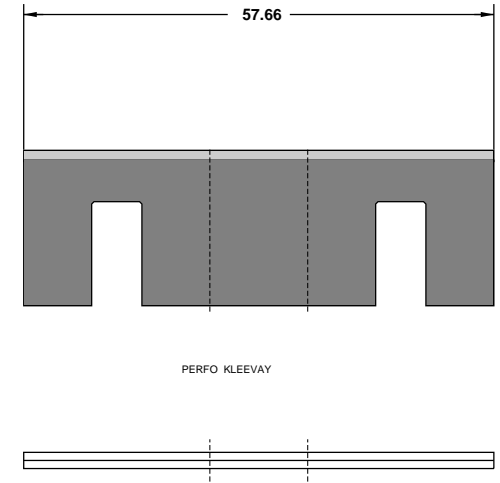

<b>22</b>	Line-No.	Date	28.02.2012	Order-No.		Amount	16	Supplier
	Path	asercpack/filesW	Author	Yashin A	Height	23.80	Laserpack Fryazino	
	File	c> ECMA_A2220	Customer		Manufacturer	Boehler		
	10/15/18		Line type	PERFO	Material	UNIVERSAL-T30		
	Sonstiges		Pointage	2.00	Mat. Table	04	Die-Side	

Rule Processing System ACS 100 for ISO 9000

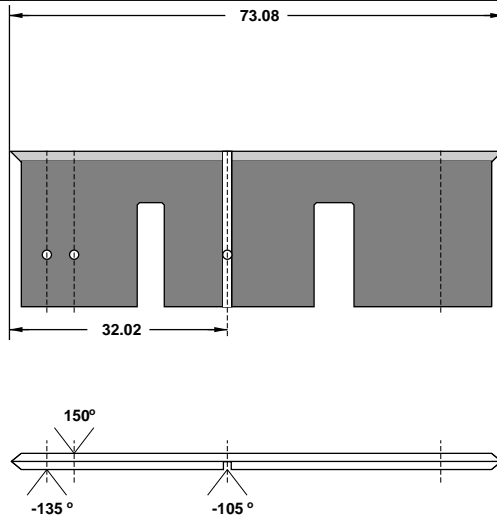
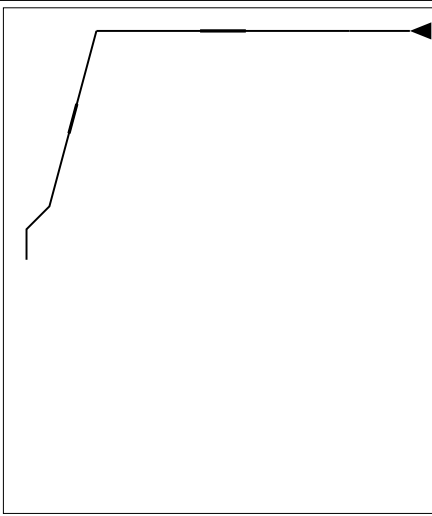

<b>23</b>	Line-No.	Date	28.02.2012	Order-No.		Amount	16	Supplier
	Path	asercpack/filesW	Author	Yashin A	Height	23.80	Laserpack Fryazino	
	File	c> ECMA_A2220	Customer		Manufacturer	Boehler		
	10/15/18		Line type	Cut	Material	UNIVERSAL-T30		
	Sonstiges		Pointage	2.00	Mat. Table	04	Die-Side	

Rule Processing System ACS 100 for ISO 9000

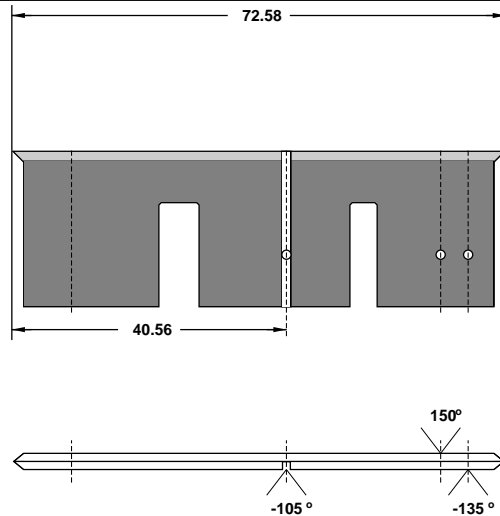
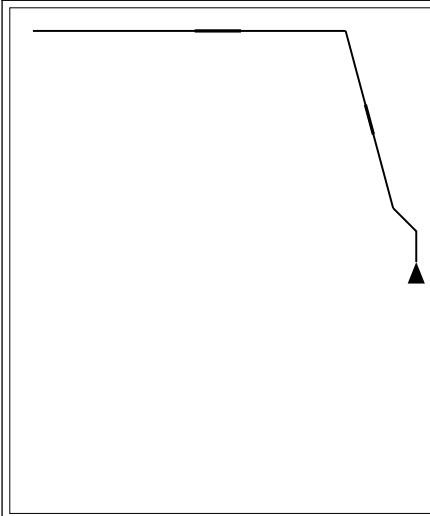

<b>24</b>	Line-No.	Date	28.02.2012	Order-No.		Amount	16	Supplier
	Path	asercpack/filesW	Author	Yashin A	Height	23.80	Laserpack Fryazino	
	File	c> ECMA_A2220	Customer		Manufacturer	Boehler		
	10/15/18		Line type	Cut	Material	UNIVERSAL-T30		
	Sonstiges		Pointage	2.00	Mat. Table	04	Die-Side	

Rule Processing System ACS 100 for ISO 9000

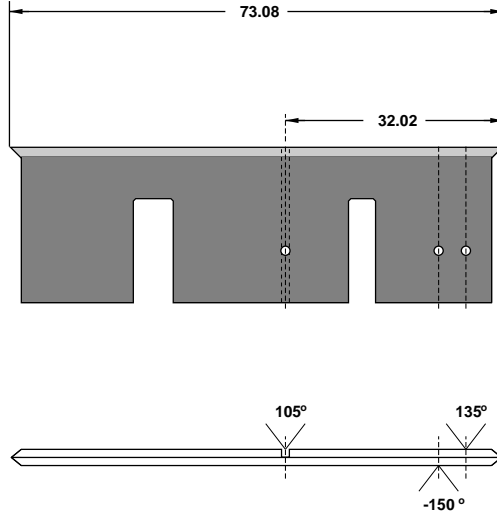
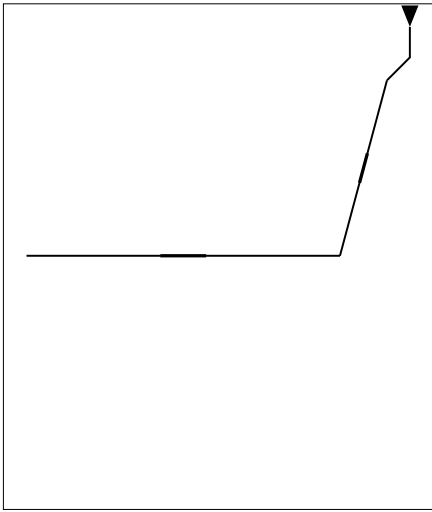

<b>25</b>	Line-No.	Date	28.02.2012	Order-No.		Amount	16	Supplier	
	Path	asercpack/filesW	Author	Yashin A	Height	23.80		Laserpack Fryazino	
	File	c> ECMA_A2220.d	Customer		Manufacturer	Boehler			
	10/15/18		Line type	Cut	Material	UNIVERSAL-T30			
	Sonstiges		Pointage	2.00	Mat. Table	04	Die-Side		

Rule Processing System ACS 100 for ISO 9000

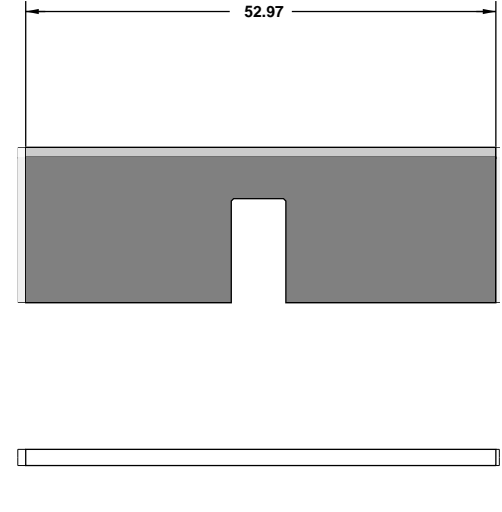
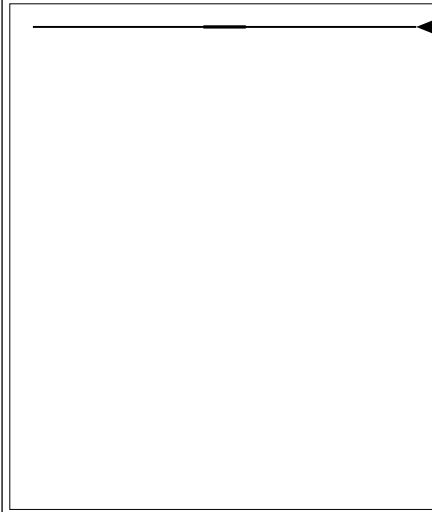

<b>26</b>	Line-No.	Date	28.02.2012	Order-No.		Amount	48	Supplier	
	Path	asercpack/filesW	Author	Yashin A	Height	23.30		Laserpack Fryazino	
	File	c> ECMA_A2220.d	Customer		Manufacturer	Boehler			
	10/15/18		Line type	Crease	Material	UNIVERSAL-T30			
	Sonstiges		Pointage	2.00	Mat. Table	04	Die-Side		

Rule Processing System ACS 100 for ISO 9000

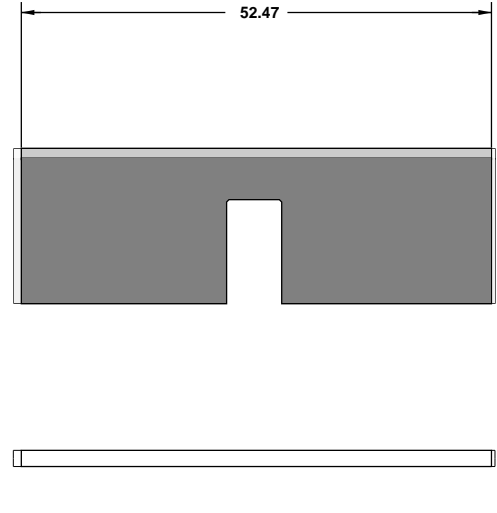
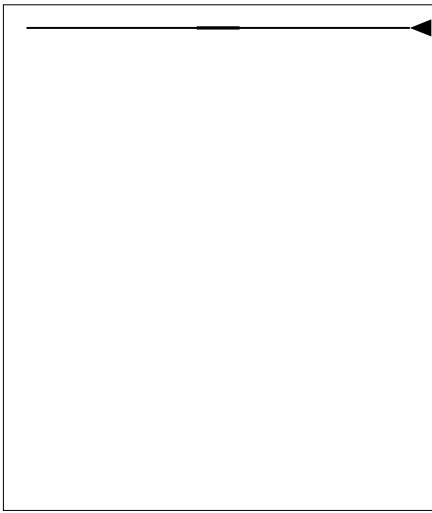

<b>27</b>	Line-No.	Date	28.02.2012	Order-No.		Amount	16	Supplier	
	Path	asercpack/filesW	Author	Yashin A	Height	23.30		Laserpack Fryazino	
	File	c> ECMA_A2220.d	Customer		Manufacturer	Boehler			
	10/15/18		Line type	Crease	Material	UNIVERSAL-T30			
	Sonstiges		Pointage	2.00	Mat. Table	04	Die-Side		

Rule Processing System ACS 100 for ISO 9000

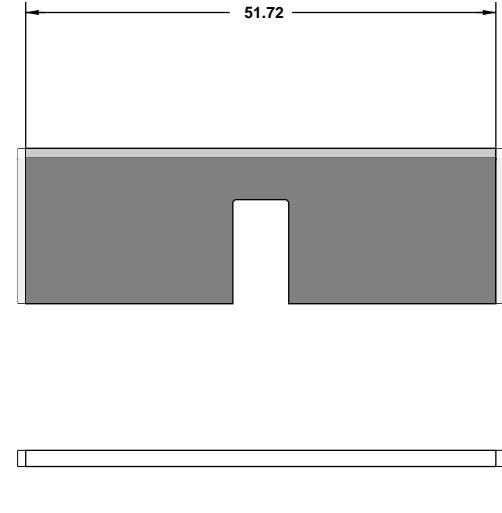
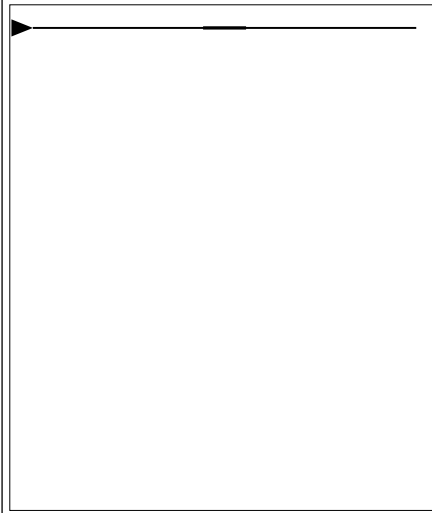

<b>28</b>	Line-No.	Date	28.02.2012	Order-No.		Amount	32	Supplier	
	Path	asercpack/filesW	Author	Yashin A	Height	23.30		Laserpack Fryazino	
	File	c> ECMA_A2220.d	Customer		Manufacturer	Boehler			
	10/15/18		Line type	Crease	Material	UNIVERSAL-T30			
	Sonstiges		Pointage	2.00	Mat. Table	04	Die-Side		

Rule Processing System ACS 100 for ISO 9000

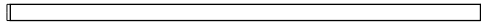
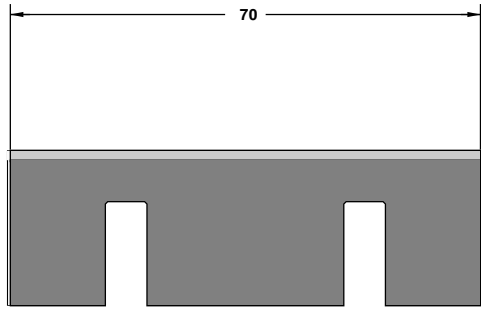
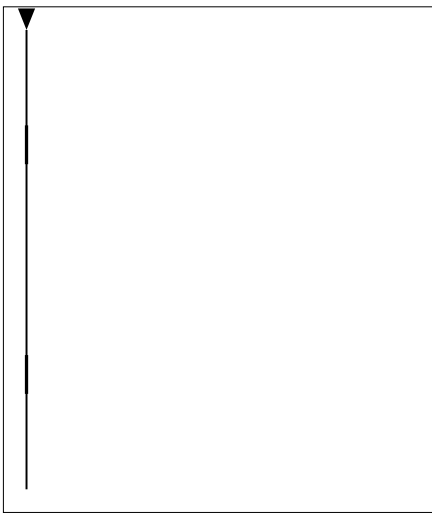

<b>29</b>	<b>Line-No.</b>		<b>Date</b>	28.02.2012	<b>Order-No.</b>		<b>Amount</b>	16	<b>Supplier</b>	
	<b>Path</b>	aserpack/filesW	<b>Author</b>	Yashin A	<b>Height</b>	23.30	<b>Laserpack Fryazino</b>			
	<b>File</b>	c> ECMA_A2220.d	<b>Customer</b>		<b>Manufacturer</b>	Boehler				
	<b>10/15/18</b>		<b>Line type</b>	Crease	<b>Material</b>	UNIVERSAL-T30				
	<b>Sonstiges</b>		<b>Pointage</b>	2.00	<b>Mat. Table</b>	04	<b>Die-Side</b>			

Rule Processing System ACS 100 for ISO 9000

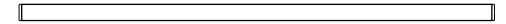
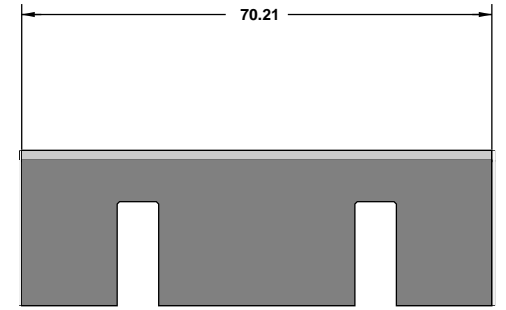

<b>30</b>	<b>Line-No.</b>		<b>Date</b>	28.02.2012	<b>Order-No.</b>		<b>Amount</b>	48	<b>Supplier</b>	
	<b>Path</b>	aserpack/filesW	<b>Author</b>	Yashin A	<b>Height</b>	23.30	<b>Laserpack Fryazino</b>			
	<b>File</b>	c> ECMA_A2220.d	<b>Customer</b>		<b>Manufacturer</b>	Boehler				
	<b>10/15/18</b>		<b>Line type</b>	Crease	<b>Material</b>	UNIVERSAL-T30				
	<b>Sonstiges</b>		<b>Pointage</b>	2.00	<b>Mat. Table</b>	04	<b>Die-Side</b>			

Rule Processing System ACS 100 for ISO 9000

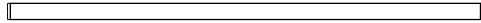
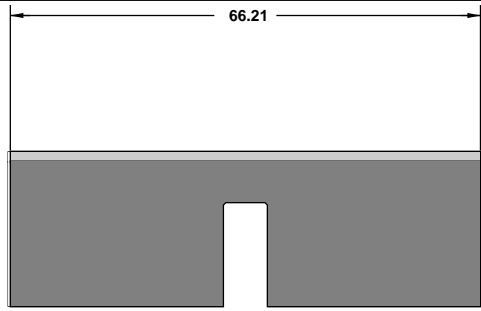
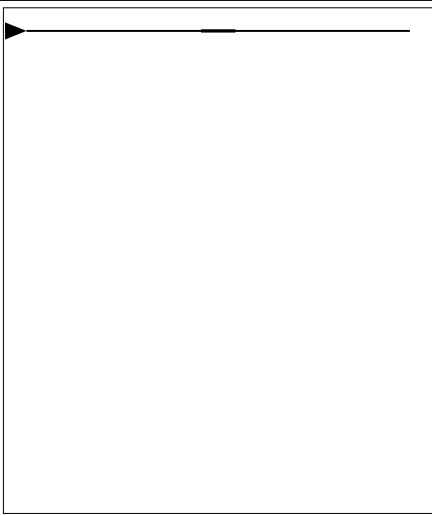

<b>31</b>	<b>Line-No.</b>		<b>Date</b>	28.02.2012	<b>Order-No.</b>		<b>Amount</b>	32	<b>Supplier</b>	
	<b>Path</b>	aserpack/filesW	<b>Author</b>	Yashin A	<b>Height</b>	23.30	<b>Laserpack Fryazino</b>			
	<b>File</b>	c> ECMA_A2220.d	<b>Customer</b>		<b>Manufacturer</b>	Boehler				
	<b>10/15/18</b>		<b>Line type</b>	Crease	<b>Material</b>	UNIVERSAL-T30				
	<b>Sonstiges</b>		<b>Pointage</b>	2.00	<b>Mat. Table</b>	04	<b>Die-Side</b>			